

LIGHT  
APP

## FEATURES

- ◆ LED DIMMER
- ◆ Power supply (DC IN): 12-24-48 Vdc
- ◆ Constant Current output (L1) for dimmable Spotlights and LED modules
- ◆ WHITE and MONOCHROME Light Control
- ◆ Hybrid Dimming up to 1.6 A
- ◆ Remote control via BUS (DALI)
- ◆ Opto-Isolated BUS Input
- ◆ Device configuration via Dalcnet LightApp® mobile application, parameters can be set:
  - Dimming Curve
  - Constant Current output level
  - DALI address
  - Power-ON and System Failure Levels
  - Transition Parameters (Fade)
  - Groups and Scenarios
- ◆ Soft ON/OFF
- ◆ Soft brightness dimming
- ◆ Extended temperature range
- ◆ 100% Functional test

## PRODUCT DESCRIPTION

SLIM-1CC-DALI is a 1-channel Hybrid modulated Constant Current (CC) LED dimmer, which can be connected to a SELV constant voltage (12 ÷ 48) Vdc power supply. Hybrid modulation consists of a smart selection between Amplitude Modulation (AM) and Pulse-Width Modulation (PWM), depending on the current delivered by the output stage: typically, the AM modulation operates for high output currents (> 350 mA), instead of PWM modulation that applies for lower currents. The dimmer is suitable for driving loads such as Spotlight and white, single-colour, LED modules at constant current and can be controlled via DALI (Digital Addressable Lighting Interface) digital protocol. SLIM-1CC-DALI can deliver a maximum output current of 1.6 A and has the following detections and protections: open-circuit and short-circuit detection, over-voltage and under-voltage protections, reverse polarity protection and input fuse protection.

Through the Dalcnet LightApp® mobile application and smartphones equipped with Near Field Communication (NFC) technology, it is possible to configure multiple parameters when the device is powered OFF, including maximum output current, adjustment curve and maximum/minimum brightness levels. Dalcnet LightApp® can be downloaded free of charge from the Apple APP Store and Google Play Store.

→ For the most up-to-date manual, please consult our website [www.dalcnet.com](http://www.dalcnet.com) or QR Code.



## PRODUCT CODE

CODE	POWER SUPPLY	LED OUTPUTS	N° OF CHANNELS	REMOTE CONTROL	APP CONFIG
SLIM-1CC-DALI	12-24-48 VDC	1 x 1.6 A <sup>1</sup>	1	DALI	LightApp®

Table 1: Product Code

## PROTECTION AND DETECTION

The following table shows the types of incoming and outgoing protection/detection present on the device.

CODE	DESCRIPTION	TERMINAL	PRESENT
IFP	Input Fuse Protection <sup>2</sup>	DC IN	✓
OVP	Over Voltage Protection <sup>2</sup>	DC IN	✓
UVP	Under Voltage Protection <sup>2</sup>	DC IN	✓
RVP	Reverse Voltage Polarity <sup>2</sup>	DC-IN	✓
SCD	Short-Circuit Detection	L1	✓
OCD	Open-Circuit Detection	L1	✓

Table 2: Detection and Protection functionalities

## REFERENCE STANDARDS

SLIM-1CC-DALI follows the regulations shown in the table below.

STANDARD	TITLE
EN 55015	Limits and methods of measurement of radio disturbance characteristics of electrical lighting and similar equipment
EN 61547	Equipment for general lighting purposes – EMC immunity requirement
EN 61347-1	Lamp Controlgear – Part 1: General and safety requirement
EN 61347-2-13	Lamp controlgear - Part 2-13: Particular requirement for d.c. or a.c. supplied electronic Controlgear for LED modules
IEC 62386-101 ED2	Digital addressable lighting interface – Part 101: General requirements – System components
IEC 62386-102 ED2	Digital addressable lighting interface – Part 102: General requirements – Control gear
IEC 62386-207 ED2	Digital addressable lighting interface – Part 207: Particular requirements for control gear – LED modules (device type 6)

Table 3: Reference standards

<sup>1</sup> The maximum total output current depends on the operating conditions and ambient temperature of the system. For the correct configuration, check the maximum power that can be delivered in the §[Technical Specifications](#) and in the §**Errore. L'origine riferimento non è stata trovata.** sections.

<sup>2</sup> Protections refer to the control logic of the board.

## TECHNICAL SPECIFICATIONS

Description	Name	Values			Unit of Measure	Note
		Min		Max		
<b>INPUT (Power Supply DC IN)</b>						
Nominal Supply Voltage	V <sub>IN</sub>	12	24	48	Vdc	-
Supply Voltage range	V <sub>IN-RNG</sub>	10.8	÷	52.8	Vdc	-
Efficiency at full load	E <sub>FF</sub>	> 95			%	-
Standby power absorption	P <sub>STBY</sub>	< 0.5			W	-
<b>OUTPUT (Channel L1)</b>						
Output Current	I <sub>OUT</sub>	350, 500, 700, 900, 1050, 1200, 1400, 1600			mA	Choice via Dalcnet LightApp®
Output Current (max)	-	45 ≤ T <sub>A</sub> < 60	35 ≤ T <sub>A</sub> < 45	T <sub>A</sub> < 35 °C	°C	-
	I <sub>OUT-max</sub>	1050	1200	1600	mA	Output current set to I <sub>OUT</sub> = 1600 mA
Output Voltage	-	@12V	@24V	@48V		-
	V <sub>OUT-I ≤ 1.05A</sub>	2 ÷ 10	6 ÷ 21	12 ÷ 43	V	For output current I <sub>OUT</sub> ≤ 1050 mA
	V <sub>OUT-I &gt; 1.05A</sub>	2 ÷ 9	6 ÷ 20	12 ÷ 42		For output current I <sub>OUT</sub> > 1050 mA
Rated Power Output	P <sub>OUT</sub>	See Table 5			W	Rated @ T <sub>A</sub> < 35 °C.
Load type	L <sub>TYPE</sub>	LED			-	Defined by design
<b>DIMMING</b>						
Hybrid Dimming Threshold	HD <sub>TH</sub>	22	÷	100	%	According to the selected Dimming Curve and output current set
Modulation Current Threshold	I <sub>TH</sub>	350			mA	-
Hybrid Modulation working	-	I <sub>OUT</sub> ≤ I <sub>TH</sub>	I <sub>OUT</sub> > I <sub>TH</sub>		-	-
	HM	PWM*	AM		-	*PWM frequency fixed to 3400 Hz
Dimming Curve	C <sub>DIM</sub>	Linear	Logarithmic		-	Choice via Dalcnet LightApp®
Dimming Resolution	Res <sub>DIM</sub>	16			bit	Defined by design
Dimming range	RNG <sub>DIM</sub>	1	÷	100	%	-
<b>ENVIRONMENTAL</b>						
Storage temperature	T <sub>STORE</sub>	-40	÷	+60	°C	Minimum values defined by design
Working Ambient temperature	T <sub>A</sub>	-10	÷	+60	°C	
Max Temperature @ T <sub>c</sub> point	T <sub>C</sub>	-	-	+80	°C	-
Wiring Section	WS <sub>SOLID</sub>	0.2	÷	1.5	mm <sup>2</sup>	Defined by design
	WS <sub>STRAND</sub>	24	÷	16	AWG	
Strip length	WS <sub>STRIP</sub>	9*	÷	10	mm	*Wago 805-356 connector only
Protection class	IP <sub>CODE</sub>	IP20			-	-
Mechanical Dimensions	-	L	H	D		-
	MD	186	29	21	mm	-
Weight	W	80			g	-

Table 4: Technical specification

Rated Power Output (P <sub>OUT</sub> )	Current [mA] ± 5%	350	500	700	900	1050	1200	1400	1600
	@12 Vdc	3.5 W	5 W	7 W	9 W	10.5 W	10.8 W	12.6 W	14.4 W
	@24 Vdc	7.3 W	10.5 W	14.7 W	18.9 W	22 W	24 W	28 W	32 W
@48 Vdc	15 W	21.5 W	30.1 W	38.7 W	45.1 W	50.4 W	58.8 W	67.2 W	

Note: values rated with working ambient temperature T<sub>A</sub> < 35 °C.

Table 5: Rated Power Output for each current set

## T<sub>c</sub> POINT POSITIONING

The figure below shows the positioning of the maximum temperature point ( $T_c$  point, highlighted in red) reached by the electronics inside the enclosure. It is located on the front side (Top) near the LED output connector.



Figure 1: T<sub>c</sub> point position

## INSTALLATION



**ATTENTION!** Installation and maintenance must always be conducted in the absence of voltage.

Before continuing with the connection of the device to the power supply, make sure that the voltage of the power source is disconnected from the system.



The device should only be connected and installed by qualified personnel. All applicable regulations, legislation, standards, and building codes must be adhered to. Incorrect installation of the device may cause irreparable damage to the device and connected loads.

The following paragraphs show the diagrams of the dimmer's connection to the remote control, the load and the supply voltage. It is recommended to follow these steps to install the product safely:

1. **Load wiring:** connect the LED load positive to the "L1" terminal with the "+" symbol, and the LED load negatives to the "L1" terminal with the "-" symbol.
2. **Remote Control wiring:** connect the DA data bus signals to the "DALI" terminals with the "DA" symbols.
3. **Power wiring:** connect a 12-24-48 Vdc constant voltage SELV power supply (depending on the nameplate data of the LED load) to the "+" and "-" terminals of the DC IN terminal.



Note: no local control (e.g. push-button, potentiometer, 1-10V signal, etc.) terminal is provided.

## LOAD CONNECTION

SLIM-1CC-DALI has 1 output channel that can be driven independently (e.g. for spotlight LED modules).

### DIAGRAM FOR WHITE OR SINGLE-COLOUR LED LOADS

The following connection diagram (Figure 2) allows to drive 1 white or single-colour LED load, on output channel L1.



Figure 2: Connection diagram for White or Single-Colour LED loads

**REMOTE CONTROL CONNECTION**

SLIM-1CC-DALI can be controlled remotely via DALI digital bus by a simple two-wire cable (untwisted and unshielded). The control is conducted by a DALI Master, which provides commands to the devices in the DALI network and, if necessary, power supply<sup>3</sup> to the network itself.

 To connect SLIM-1CC-DALI to the DALI network, simply connect the bus cables to the "DA" terminals of the "DALI" terminal: as different topologies are possible, it is not necessary to observe the polarity of the "DA+" and "DA-" signals of the bus when connecting.

*DALI CABLING TOPOLOGIES*

The DALI protocol supports several cabling topologies, i.e. Bus-wiring, shown as an example in Figure 3.

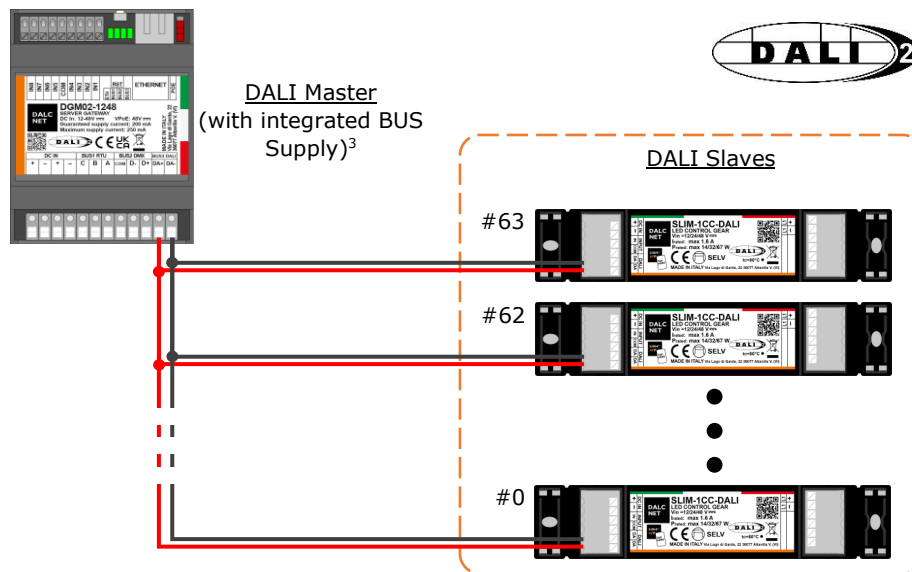

Figure 3: Remote Control Connection Topology, Bus-wiring

The DALI-2 protocol supports up to 64 Control Gear slave devices (e.g. SLIM-1CC-DALI) connected with different wiring topologies shown in Figure 4: Bus-wiring, Star-wiring, Tree-wiring, or Line-wiring. Other topologies are excluded.

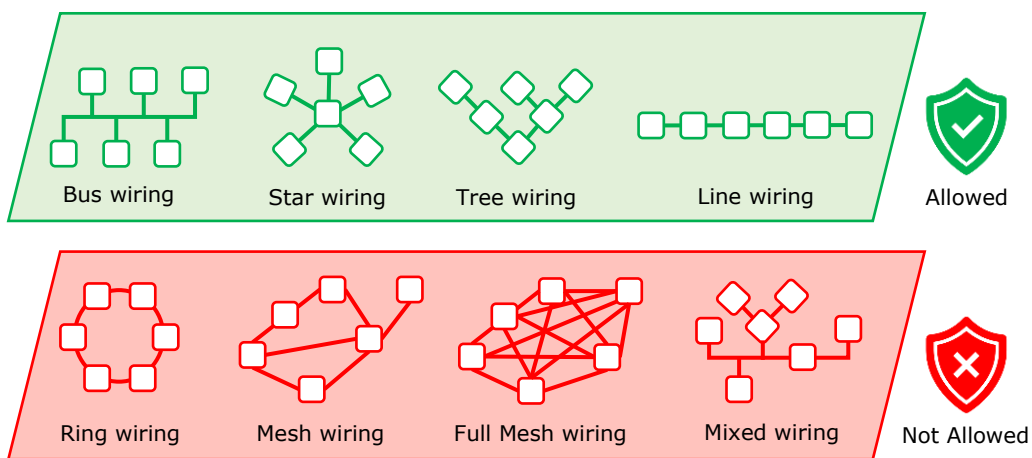



Figure 4: DALI wiring Topologies

<sup>3</sup> The bus power supply can be supplied by an external 16 Vdc power supply (or within the range of 12 ÷ 20 Vdc) or by a DALI Master with integrated bus power supply (e.g. DGM02-1248 shown in Figure 3). For more information, please visit our website: [www.dalcnet.com](http://www.dalcnet.com).

## POWER SUPPLY CONNECTION

 SLIM-1CC-DALI can be powered by a 12 Vdc, 24 Vdc or 48 Vdc constant voltage SELV power supply, depending on the operating voltage of the LED load. Once the load and Remote Control are connected, wire the power supply to the "+" and "-" terminals of the DC IN terminal.

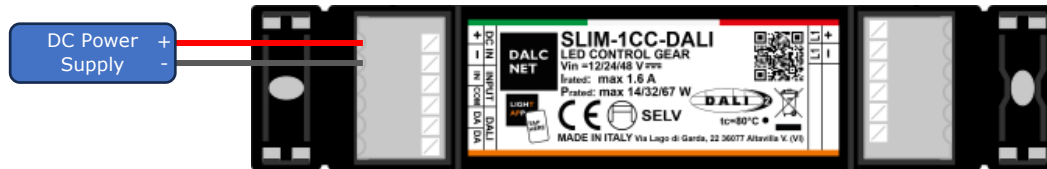

Figure 5: Power Supply Connection Diagram

## REMOTE CONTROL: DALI

DALI (Digital Addressable Lighting Interface) is a protocol developed by the DALI Alliance (DIIA) to allow the management, configuration and programming of LED lighting systems in digital mode: through a two-way communication process between devices and control units, it is possible to execute ON, OFF or dimmer commands, report faults or information of various kinds. Based on a Master/Slave architecture, the DALI standard allows both single digital control of devices and programming in groups and/or broadcast.

In its second version, DALI-2 allows first full compatibility with the earlier protocol, and secondly brings numerous improvements compared to DALI-1:

1. **Addition of lighting control devices:** e.g. buttons, sensors, and LED drivers that were not included in the earlier version. In addition, to obtain DALI-2 certification, the new protocol requires the execution of functional and compliance tests by DIIA.
2. **Introduction of the Multi Master architecture:** with the regulation of the various lighting control devices, it is possible to send commands and signals to the DALI-2 bus from multiple sources, easing independent, immediate, and simultaneous data communication.
3. **Development of functional and application standards:** new extensions have been drawn up for DALI-2 devices, e.g. for emergency lighting or colour control, creating a new product standard for smart lighting and IoT systems called D4i.

## PROFILE MAPPING: OPERATION MODE

The DALI protocol provides two configurations depending on the light characteristics to be obtained through the LED module connected to the outputs. Each profile is composed of a defined number of 8-bit channels, whose values can be set in the range (0 ÷ 255), each of which stands for a light characteristic (e.g. brightness, colour, temperature, etc.) to be modulated on the LED load.

SLIM-1CC-DALI supports only the DT6 profile to provide adjustment of the light intensity for the single output channel.

### DT6 - 1 CHANNEL

The "DT6" profile allows you to adjust the light intensity for the output channel. In the [§Diagram for White or Single-Colour LED Loads](#) section, it is possible to find details on the type of load and the most suitable connection diagram for this operating mode. It is understood that this profile can be used with all the other types of load proposed in this document (see [§Load Connection](#)) by configuring the device in the dedicated LightApp® section (see [§Channel 0](#)).

Address	Function	Level
A0	DIMMER 1	LEVEL 0...255

## FLICKER PERFORMANCE

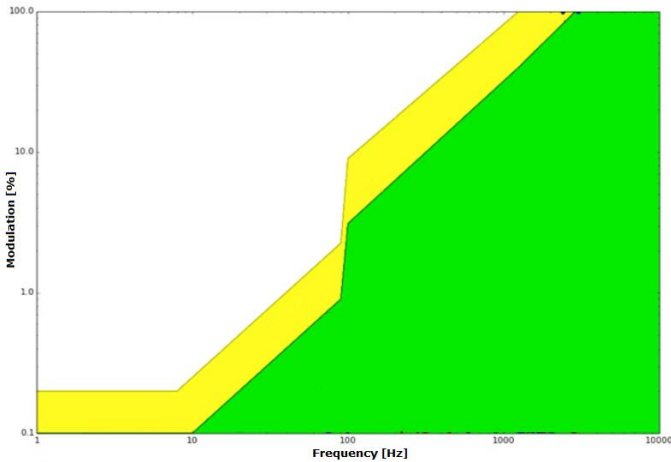

Figure 6: Flickering Perception Threshold

Thanks to the Hybrid modulation, the SLIM-1CC-DALI effectively reduces the occurrence of the Flicker phenomenon. Depending on an individual's sensitivity and the nature of their activities, flickering can affect one's well-being, even if the changes in luminance are beyond the threshold detectable by the human eye.

The graph shows the phenomenon of Flickering in function at the frequency, measured throughout the dimming range.

The results show the low-risk zone (yellow) and the no-effect zone (green), defined by IEEE 1789-2015<sup>4</sup>.

## THERMAL CHARACTERIZATION

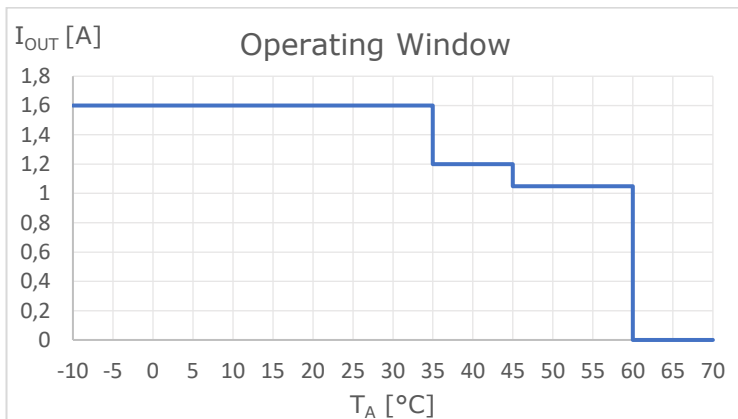

Figure 7: Operating Temperature Window

Figure 7 shows the maximum output current values that can be provided by the SLIM-1CC-DALI as a function of the operating temperature<sup>5</sup> (or ambient temperature,  $T_A$ ) of the operation, summarized below:

- ◆  $T_A = (-10 \div +35) \text{ }^\circ\text{C} \rightarrow I_{OUT} \leq 1.6 \text{ A}$
- ◆  $T_A = (+35 \div +45) \text{ }^\circ\text{C} \rightarrow I_{OUT} \leq 1.2 \text{ A}$
- ◆  $T_A = (+45 \div +60) \text{ }^\circ\text{C} \rightarrow I_{OUT} \leq 1.05 \text{ A}$

These maximum current values can only be applied under suitable ventilation conditions.

## DIMMING CURVES

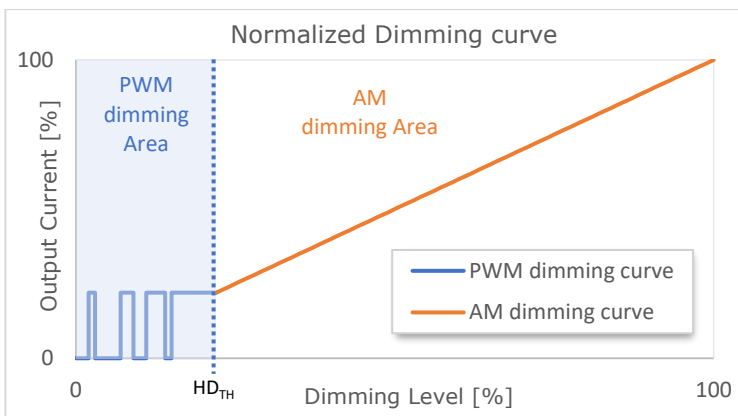

Figure 8: Normalized Dimming curve

For high currents ( $> 350 \text{ mA}$ ) over the Hybrid Dimming Threshold ( $HD_{TH}$ ), AM modulation allows to effectively regulate the brightness of the LED load. While the PWM modulation at 3.4 kHz ensures a significant reduction in the occurrence of the flickering phenomenon in the lower current range.

Figure 8 shows the Normalized dimming curve supported by the SLIM-1CC-DALI dimmer.

Figure 9 and Figure 10 show the dimming curves supported by the SLIM-1CC-DALI dimmer and the  $HD_{TH}$  value for each curve, according to the maximum output current set. Curve and Output Current selections can be done using the Dalcnet LightApp® (see §Channel 0 section of this manual).

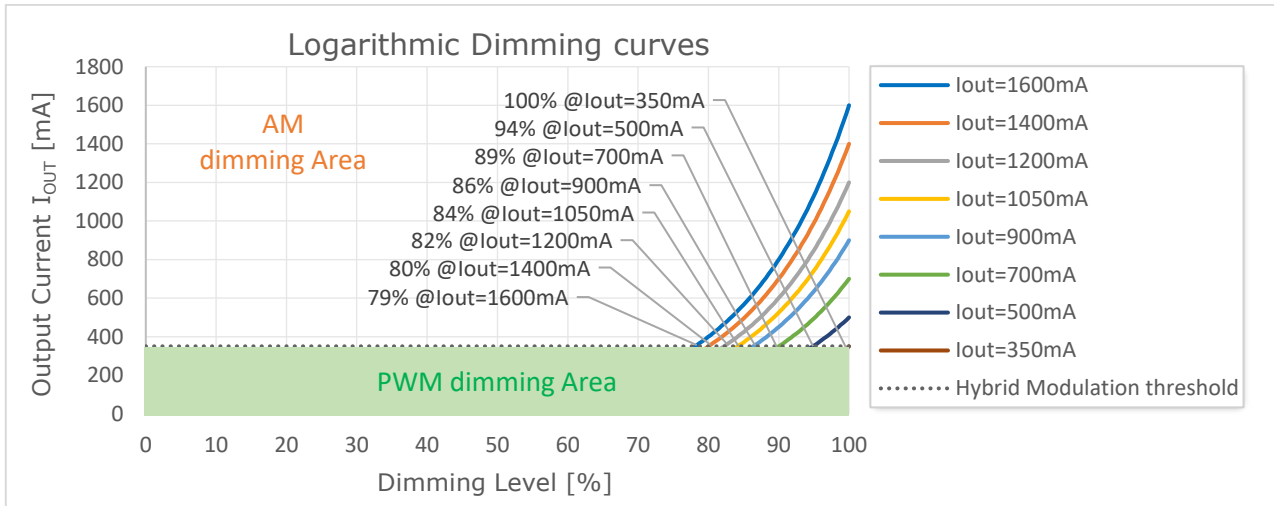

Figure 9: Logarithmic curves according to the Output Current set

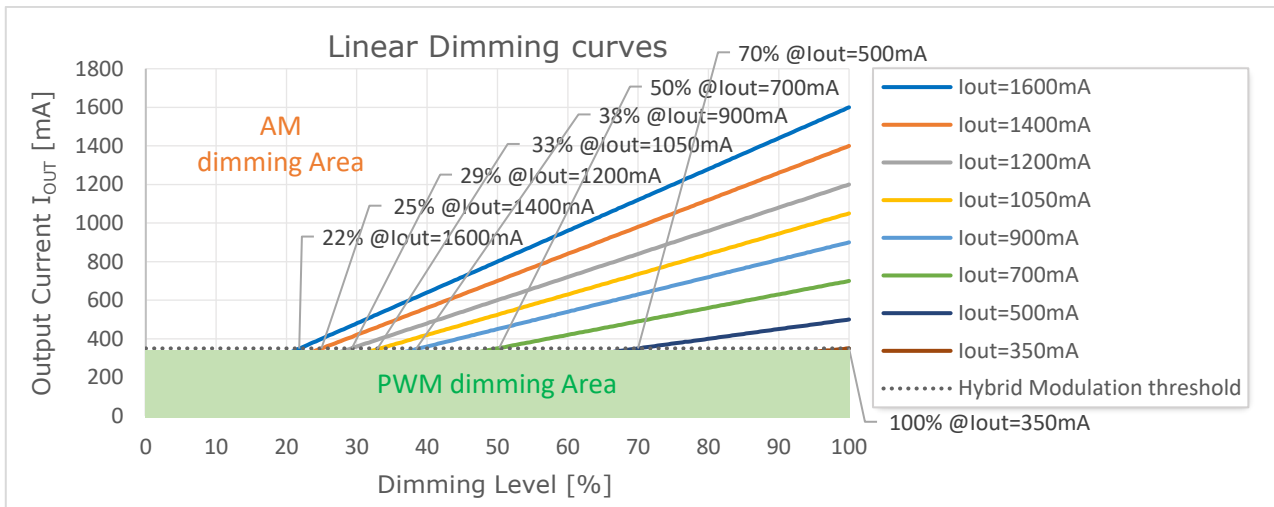

Figure 10: Linear curves according to the Output Current set

<sup>4</sup> Institute of Electrical and Electronics Engineers (IEEE). *IEEE std 1789: Recommended Practices for Modulating Current in High-Brightness LEDs for Mitigating Health Risks to Viewers.*

<sup>5</sup> If the product is installed inside an electrical panel and/or junction box, TA refers to the temperature inside the panel/box.



## MECHANICAL DIMENSIONS

Figure 11 details the mechanical measurements and the overall dimensions [mm] of the outer casing.

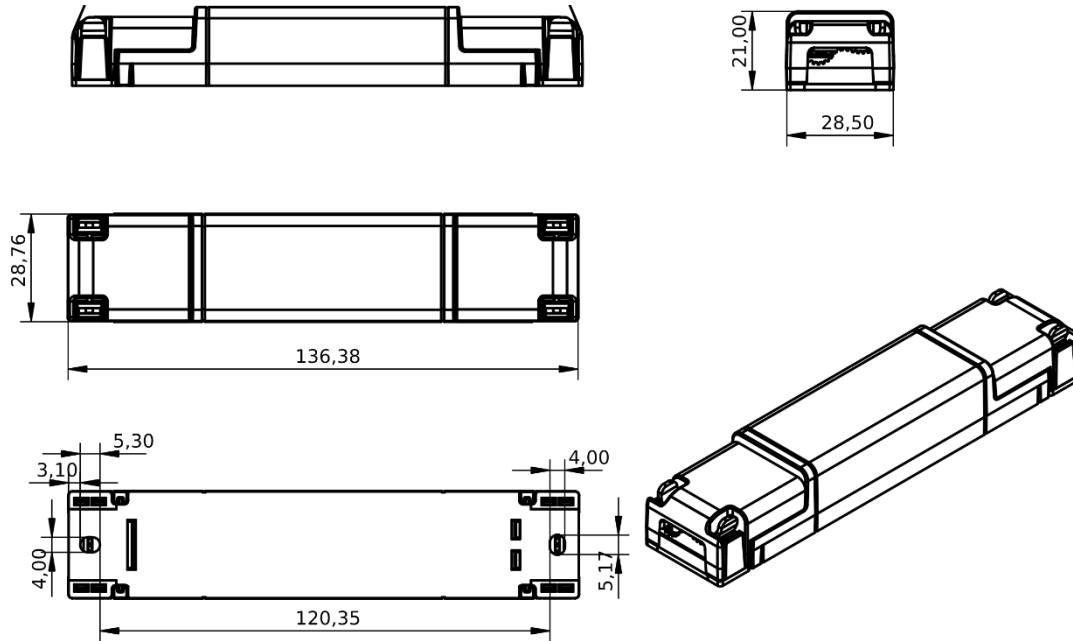

Figure 11: Mechanical dimensions

## TECHNICAL NOTES

### INSTALLATION



**WARNING!** Installation and maintenance should always be conducted in the absence of DC voltage. Before continuing with the installation, adjustment, and connection of the device to the power supply, make sure that the voltage is disconnected from the system.



The device should only be connected and installed by qualified personnel. All applicable regulations, legislation, standards, and building codes in force in the respective countries must be adhered to. Incorrect installation of the device may cause irreparable damage to the device and connected loads.

Maintenance must only be conducted by qualified personnel in compliance with current regulations.

The product must be installed inside an electrical panel and/or junction box that is protected against overvoltage.

The external power supply must be protected. The product must be protected by a properly sized circuit breaker with overcurrent protection.

Keep 230 Vac (LV) circuits and non-SELV circuits separate from SELV safety ultra-low voltage circuits and any product connections. It is strictly forbidden to connect, for any reason, directly or indirectly, the 230 Vac mains voltage to the product (control terminals included).

The product must be installed in a vertical or horizontal position, i.e. with the faceplate/label/top cover facing up or vertically. No other positions are allowed. The bottom position, i.e. with the faceplate/label/top cover facing downwards, is not allowed.

During installation, it is recommended to reserve adequate space around the device to facilitate its accessibility in case of future maintenance or updates (e.g. via smartphone, NFC).



Use in thermally harsh environments may limit the output power of the product.

For devices embedded within luminaires, the  $T_A$  ambient temperature range is a guideline to be carefully observed for the optimal operating environment. However, the integration of the device within the luminaire must always ensure proper thermal management (e.g. correct mounting of the device, proper ventilation, etc.) so that the temperature at the  $T_C$  point does not exceed its maximum limit under any circumstances. Proper operation and durability are only guaranteed if the maximum temperature of the  $T_C$  point is not exceeded under the conditions of use.

### POWER AND LOAD



The device must be powered only with SELV power supplies with limited current at constant voltage, short-circuit protection and suitably sized power according to the specifications wrote down in the product data sheet. No other types of power supply are allowed.

Size the power of the power supply respect to the load connected to the device. If the power supply is oversized compared to the maximum current drawn, insert an overcurrent protection between the power supply and the device.

Connecting to an unsuitable power supply may cause the device to work outside of the specified design limits, voiding its warranty.

In the case of power supplies equipped with earth terminals, it is mandatory to connect ALL the protection earth points (PE= Protection Earth) to a state-of-the-art and certified earthing system.

The power cables of the device must be correctly sized with reference to the connected load and must be isolated from any wiring or equal to non-SELV voltage. It is recommended not to exceed 10m of connection between the power source and the product. Use double-insulated cables. If you want to use connection cables between the power source and the product longer than 10m, the installer must ensure the correct operation of the system. In any case, the connection between the power supply and the product must not exceed 30m.



The device has been designed to work with LED loads only. Connecting and powering unsuitable loads may cause the device to work outside of the specified design limits, voiding its warranty. In general, the operating conditions of the device should never exceed the specifications wrote down in the product data sheet.

Observe the intended polarity between the LED module and the device. Any polarity reversal results in no light emission and can often damage the LED modules.

It is recommended that the connection cables between the product and the LED module be less than 3m long. Cables must be properly sized and should be insulated from any non-SELV wiring or parts. It is recommended to use double-insulated cables. If you want to use connection cables between the product and the LED module longer than 3m, the installer must ensure the correct operation of the system. In any case, the connection between the product and the LED module must not exceed 30m.

It is not allowed to connect diverse types of loads in the same output channel.

### REMOTE CONTROL



The length and type of cables connecting to the buses must follow the specifications of the respective protocols and current regulations. They must be isolated from any non-SELV wiring or live parts. It is recommended to use double-insulated cables.

All devices and control signals connected to the buses must be of the SELV type (the connected devices must be SELV or otherwise provide a SELV signal).

## NFC (NEAR FIELD COMMUNICATION) WARNINGS



The NFC antenna is located inside the device, the contact surface of which is indicated with the symbol . Position your smartphone so that its NFC antenna is in contact with the symbol on the device.



The location of the NFC sensor on the smartphone is dependent on the make and model of the smartphone itself. Therefore, it is recommended to refer to your smartphone's manual or the manufacturer's website to accurately determine where the NFC sensor is located. In most cases, the NFC reader is located on the back side near the top of the smartphone.

NFC technology works optimally with non-metallic materials. Therefore, it is not recommended to place the device near metal objects or reflective surfaces when using NFC.

For reliable communication, make sure that the contact surface is not covered or that it is free of metal objects, wiring, or other electronic devices. Any impediments could affect the quality of communication.

NFC technology works at a short distance, generally within a few centimeters. Make sure your device and smartphone are close enough to allow communication.

During firmware update and configuration, you should keep stable contact (possibly without movement) between your smartphone and the device for the entire duration of the process (typically between 3 and 60 seconds). This ensures that the update goes smoothly, and that the device is ready to use after the process is complete.

## LEGAL NOTES

### TERMS OF USE





Dalcnet Srl (hereinafter referred to as "the Company") reserves the right to make changes to this device, in whole or in part, without prior notice to the customer. Such changes may affect technical aspects, functionality, design, or any other element of the device. The company is not required to notify you of such changes and that your continued use of the device will constitute your acceptance of the changes.

The company is committed to ensuring that any changes do not compromise the essential functionality of the device and that they comply with applicable laws and regulations. In the event of substantial changes, the company undertakes to provide clear and timely information on the same.

The customer is advised to periodically consult the [www.dalcnet.com](http://www.dalcnet.com) website or other official sources to check for any updates or changes to the device.

## SYMBOLS

	All products are manufactured in compliance with European Regulations, as reported in the Declaration of Conformity.
	Independent Power Supply Unit: Lamp power supply unit, consisting of one or more separate elements, designed so that they can be mounted separately on the outside of a luminaire, with protection in accordance with the marking and without the use of additional enclosures.
<b>SELV</b>	"Very Low Safety Voltage" in a circuit isolated from the mains supply by insulation not less than that between the primary and secondary circuits of a safety isolation transformer according to IEC 61558-2-6.
	At the end of its useful life, the product described in this data sheet is classified as waste from electronic equipment and cannot be disposed of as unsorted municipal solid waste. <b>Warning!</b> Improper disposal of the product may cause serious harm to the environment and human health. For proper disposal, inquire about the collection and treatment methods provided by the local authorities.

## LIGHTAPP

### LIGHT APP

LightApp® is the official Dalcnet application through which it is possible to configure, in addition to the functions of the SLIM-1CC-DALI, also all the different Dalcnet products equipped with NFC technology.

Dalcnet LightApp® can be downloaded free of charge from the Apple App Store and Google Play Store.



## START-UP AND FIRST INSTALLATION

### START SCREEN - CONFIGURE

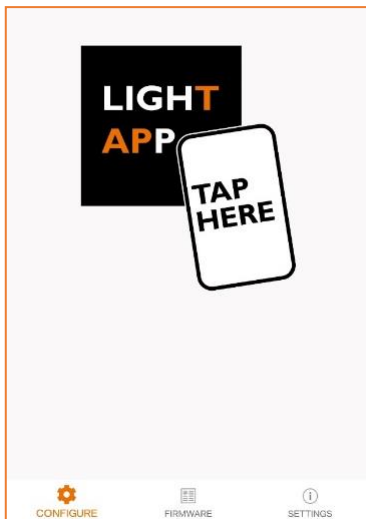

On this screen, the app waits for the device parameters to be read.

To read the parameters, simply bring the back of the smartphone close to the device's label. The read-sensitive zone of the smartphone may vary depending on the model.

Once the connection is set up, a quick loading screen will appear. You must remain in position with your smartphone until the parameters are fully loaded.

iOS variant: To read the parameters, you need to press the SCAN button at the top right. A pop-up will appear showing when your smartphone is ready to scan. Move the smartphone closer to the device and remain in place until the parameters are fully loaded.

### SETTINGS

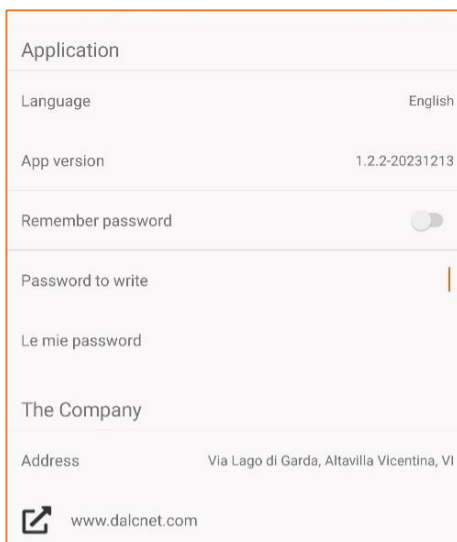

On the Settings page, you can:

- ◆ Setting the language of the app (Italian or English)
- ◆ View the app version
- ◆ Enable password saving on your smartphone
- ◆ Setting the Password for Writing Parameters
- ◆ View your saved passwords
- ◆ View the references of the distribution company (Dalcnet Srl)

## FIRMWARE

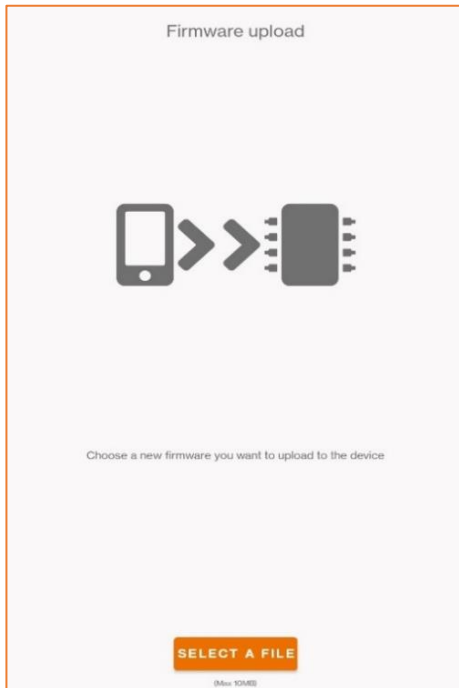

On the firmware page, you can update the firmware of your device.

The requested file must be of type *.bin*.

Once the file has been uploaded, simply follow the on-screen instructions.

### ATTENTION:

- ◆ **The upload procedure is irrevocable. Once the upload has started, it will not be possible to pause it.**
- ◆ **If the procedure is interrupted, the firmware will be corrupted, and you will need to repeat the loading procedure.**
- ◆ **At the end of the firmware load, all previously set parameters will be reset to factory defaults.**

If the update is successful and the loaded version is different from the earlier one, the device will flash 10 times on the connected load.

## LOADING PARAMETERS

**IMPORTANT: The parameters must be written when the device is switched OFF (without input power).**

### READ



With the app in READ mode, the smartphone will scan the device and show its current configuration on the screen.

### WRITE

In WRITE mode, the smartphone will write the parameter configuration set on the screen to the device.

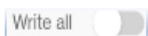

In normal mode (*Write All* switched OFF) the app writes only the parameters that have changed since the previous read. In this mode, the write will only be successful if the serial number of the device matches the one previously read.

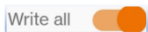

In *Write All* mode, all parameters are written. In this mode, the write will only be successful if the device model matches the one previously read.

**It is recommended to activate the *Write All* mode only when you need to replicate the same configuration on many examples of the same model.**

### WRITE PROTECTION



By the padlock button it is possible to set a lock when writing parameters. A screen will appear for entering a 4-character password. Once this password has been written into the device, all next parameter changes can only be made if the correct password is written on the app's Settings page.

To remove the password lock, simply press the lock key and leave the Password field blank.

## WRITE ERROR

After writing the parameters, if the load connected to the device flashes continuously at a frequency of 2 times per second when it is turned ON again, it means that the writing was not successful. Therefore, you will need to perform the following steps:

1. Turn OFF the device.
2. Perform a parameter rewrite.
3. Wait for the write to be successful or for no error messages to appear.
4. Turn the device back ON.

If that doesn't work, you can perform a factory reset by quickly turning the device OFF and ON 6 times.

## PRODUCT INFORMATION

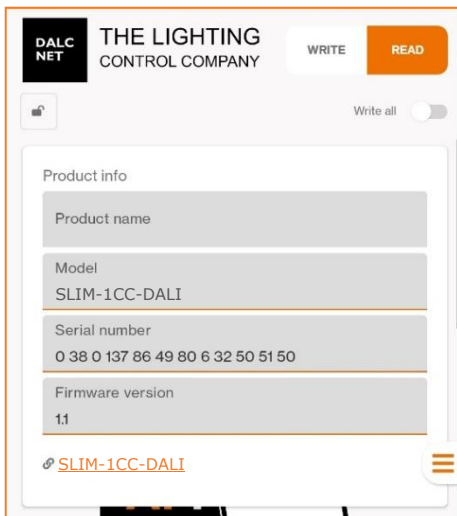

On the *Product Information* screen, you can view a variety of information about the product you are about to configure.

**Product Name:** User-settable field for easy identification (e.g. Office, Meeting Room, Lobby, etc.). By default, the product name is the same as the Model field.

**Model:** the model of the device (non-editable field).

**Serial Number:** uniquely identifies the device (non-editable field).

**Firmware Version:** shows the firmware version currently loaded on the device (non-editable field).

## GENERAL PARAMETERS

The following information can be viewed via LightApp®.



**Operating mode:** selects the operating mode.

**Current max output:** Sets the constant current level of the output channel. Values selectable are [mA]: 350, 500, 700, 900, 1050, 1200, 1400, 1600.

**DALI Firmware:** shows the DALI firmware version currently loaded on the device (non-editable field).

**GTIN:** the unique DALI code of the product (non-editable field).

**Identification Number:** serial number of the microcontroller (non-editable field).

## OPEN-CIRCUIT AND SHORT-CIRCUIT DETECTION

By the Lamp-Failure command, the DALI protocol allows you to detect situations in which the LED load connected to the output of the SLIM-1CC-DALI may not work as expected, such as an incorrect connection (detecting it as an Open Circuit error) or a defect in the LED load (detecting it as a short circuit).

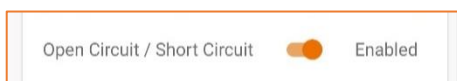

**Open/Short Circuit detection:** Enables or Disables the Open Circuit and the Short Circuit detections.

## CHANNEL 0

The following parameters can be displayed and configured for the output channel 0.

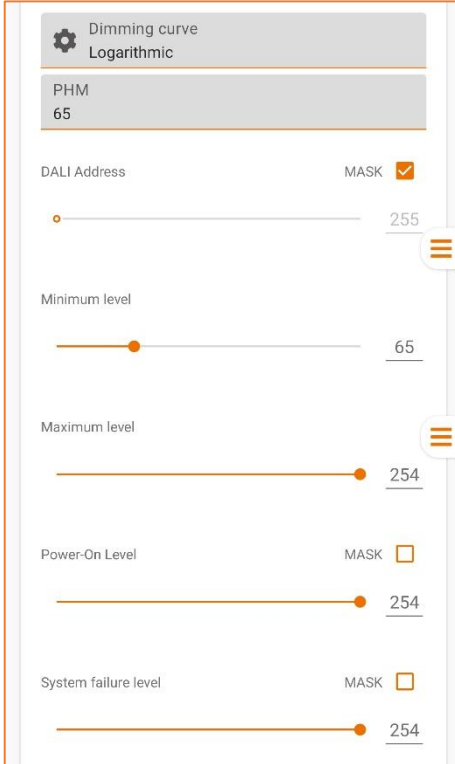

Dimming curve  
Logarithmic

PHM  
65

DALI Address MASK

255

Minimum level

65

Maximum level

254

Power-On Level MASK

254

System failure level MASK

254



Fade rate  
44,7

Fade time  
Extended fade time

Fast fade time  
25mS

Minimum fast fade time  
1

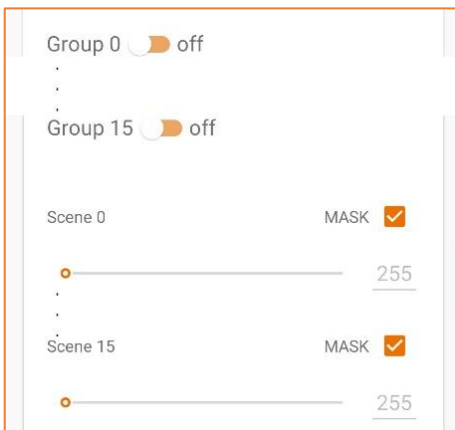

Group 0  off

⋮

Group 15  off

Scene 0 MASK

255

⋮

Scene 15 MASK

255

**Dimming Curve:** Sets the dimming curve of the device for operation with remote control. For details on the different curves that can be set, see the §Dimming Curves section of this manual.

**PHM:** Indicates whether the switched-on device is switchable only (PHM=254) or dimmable (PHM<254) (non-editable field).

**DALI Address:** Sets the address associated with the device in the DALI network.

Mask: Enables or disables control.

**Minimum Level:** sets the minimum level of light intensity that can be reached via remote control (default value = 1).

**Maximum Level:** sets the maximum level of light intensity that can be reached via remote control (default value = 254).

**Power-On Level:** this is the intensity value to which the output is brought as soon as the device is powered.

Mask: Enables or disables control.

**System Failure Level:** this is the intensity value to which the output is brought when a system error occurs.

Mask: Enables or disables control.

**Fade rate:** indicates the amount of light intensity levels into which the fade time should be divided.

**Fade time:** sets the time it takes for the output to make a transition from one light intensity level to another.

**Fast fade time:** sets the amount of time it takes for the output to make a *quick* transition from one light intensity level to another.

**Minimum fast fade time:** Shows the minimum time for the fast transition (non-editable field).

**Group 0-15:** allows to associate the device address with one or more groups.

**Scene 0-15:** allows to pair the device with one or more scenes.

Mask: Enables or disables control.